

INSTRUCTION

LINEDO
952330.853.776.000

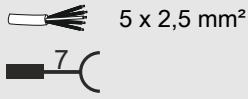

≈ 220 - 240 V 0/50/60 Hz IP 54 IK03



Umgebungstemperatur /
temperature ambiante
=> -25 °C ... + 50 °C

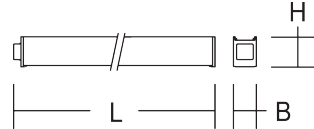
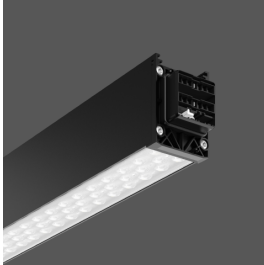

L 2291, B 58, H 76



LED



5,25 kg

Φ_{H} [lm]

6800

P_{H} [W]

40

P_{L}

4 x 19,7 W

CCT [K]

5000

CRI

80

RG $\text{\textcircled{H}}$

RG 1

EEK $\text{\textcircled{H}}$

A++

EEK $\text{\textcircled{H}}$

A++

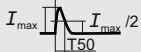

5 A / 870 μ s



23



36



38



61

P_f

0,98

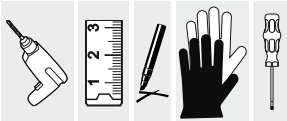

INSTRUCTION
WARTUNGSPLAN/
MAINTENANCE
SCHEDULE



DIN EN 61340-5-1



EN 12464
EN 13201



EN 12464
EN 13201



INSTRUCTION
WARTUNGSPLAN/
MAINTENANCE
SCHEDULE

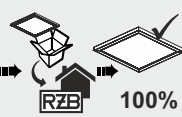

100%

EN 12464

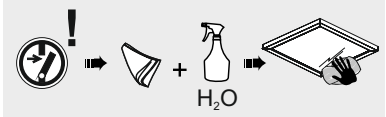

H₂O



1

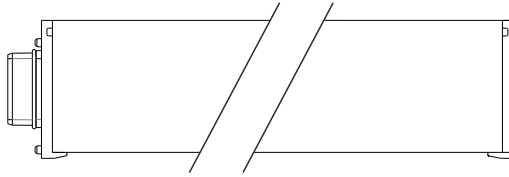

2a

	L	X*
4547 mm	≤ 4500 mm	≤ 60000 mm
2291 mm	≤ 2270 mm	≤ 50000 mm

* R_{PE} < 0,5 Ω
EN 60598

2b

	L	X*
4547 mm	≤ 4500 mm	≤ 60000 mm
2291 mm	≤ 2270 mm	≤ 50000 mm

* R_{PE} < 0,5 Ω
EN 60598

2c

	L	X*
4547 mm	≤ 2200 mm	≤ 60000 mm
2291 mm	≤ 1100 mm	≤ 50000 mm

* R_{PE} < 0,5 Ω
EN 60598

4547 mm
2291 mm ≥ 2x

< 2291 mm ≥ 1x



2d

	L	* X
4547 mm	≤ 2200 mm	≤ 60000 mm
2291 mm	≤ 1100 mm	≤ 50000 mm

* $R_{PE} < 0,5 \Omega$
EN 60598

4547 mm
2291 mm $\geq 2x$

< 2291 mm $\geq 1x$

3

4

Ø5,2

SW 14

5

24 mm

SW 7

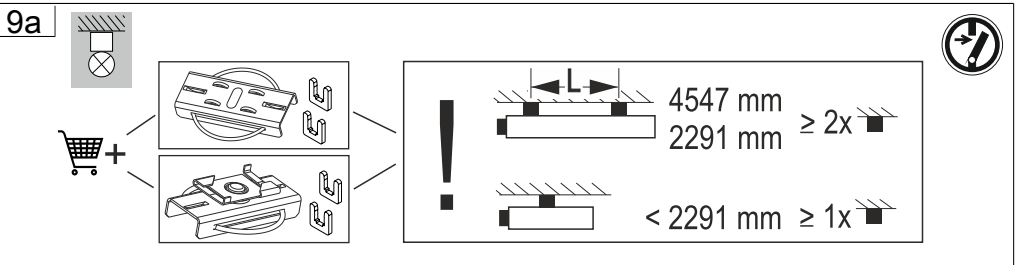
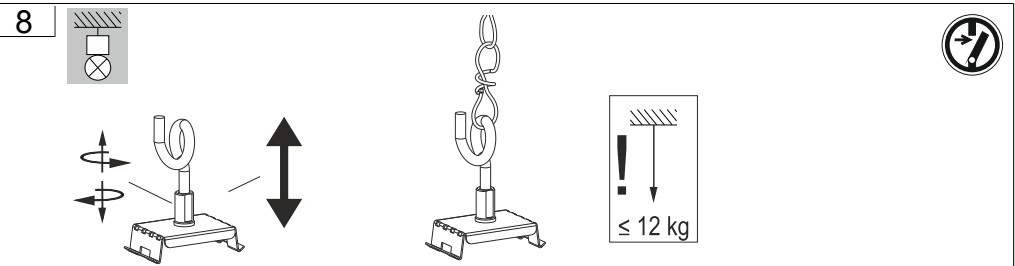
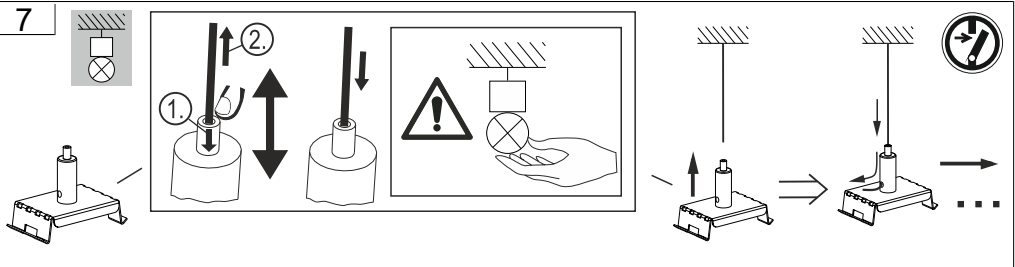
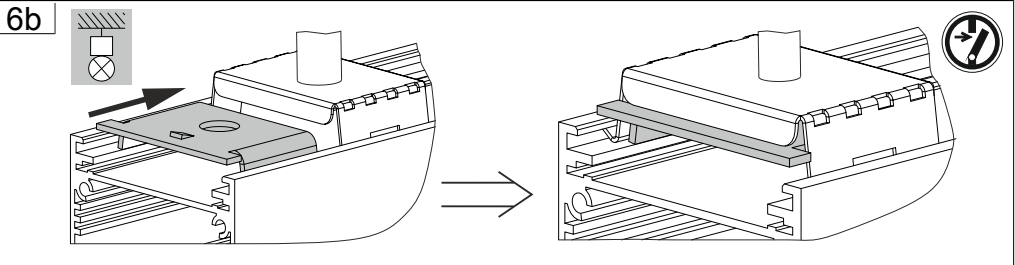
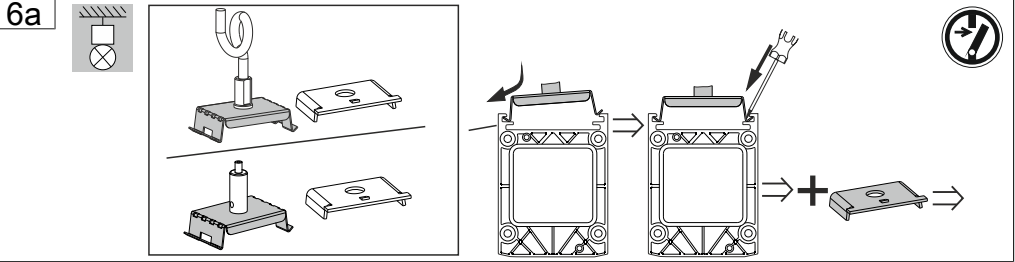

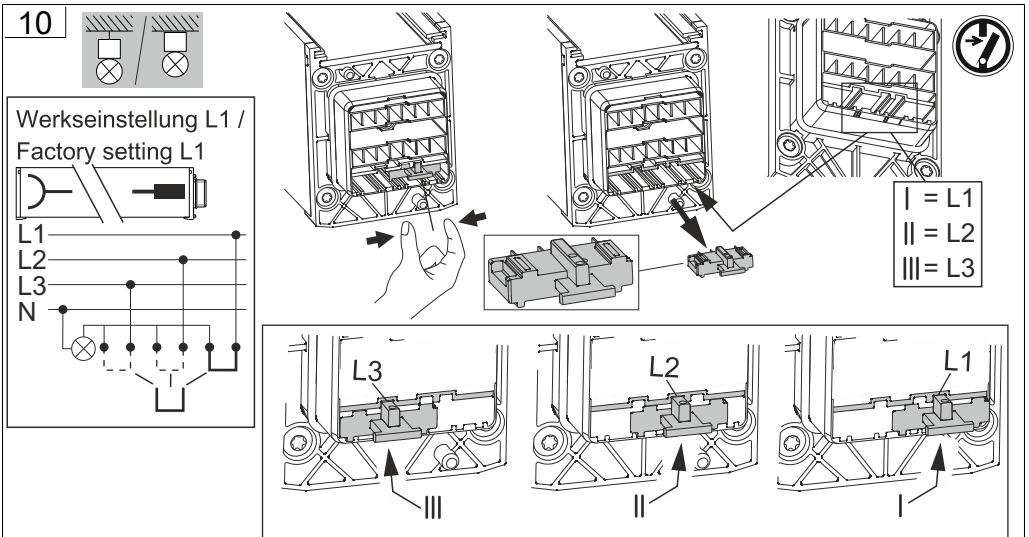
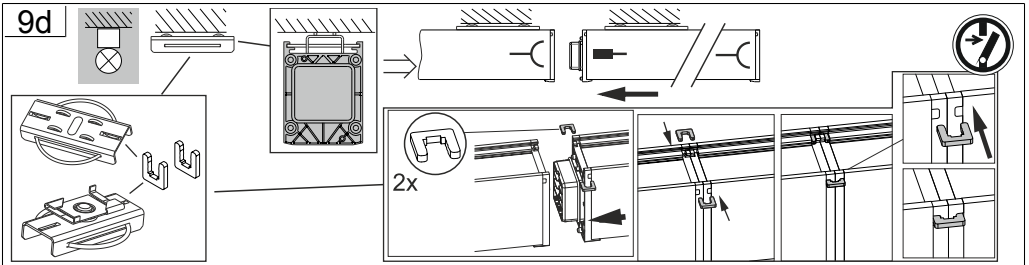
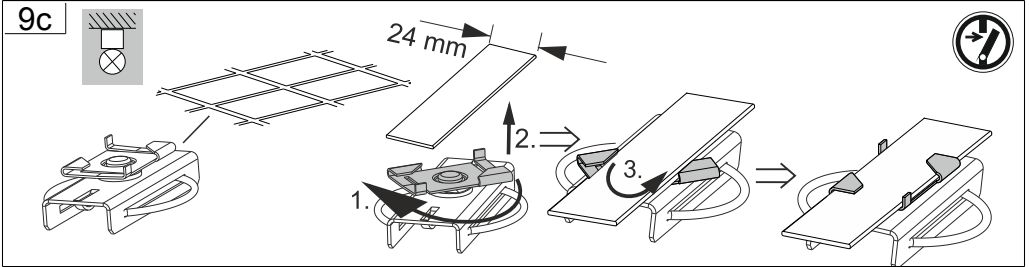
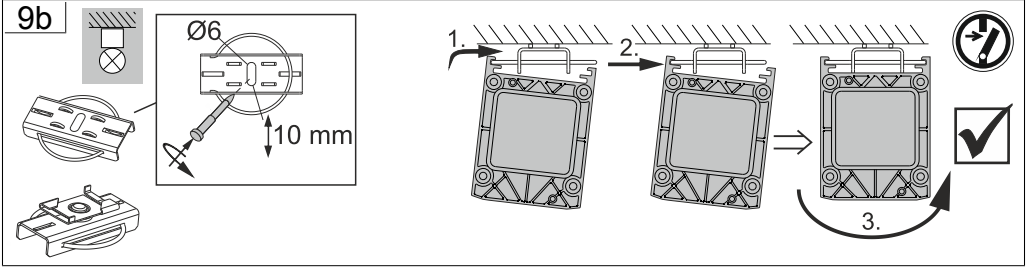

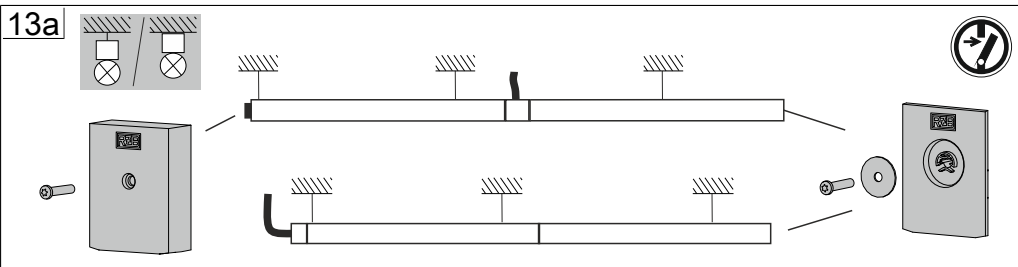
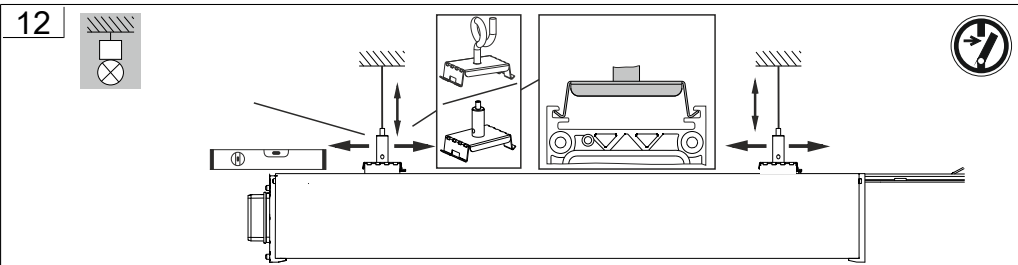
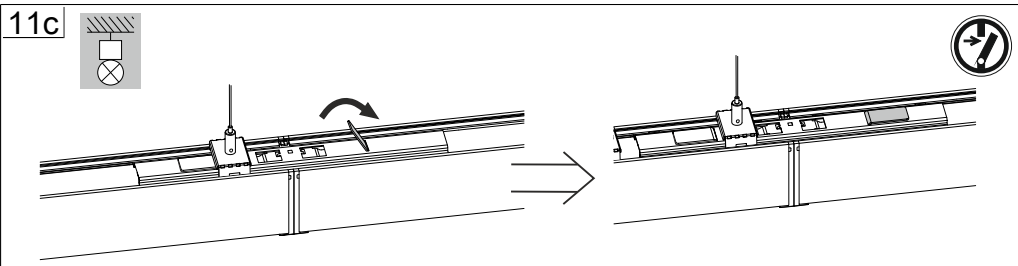
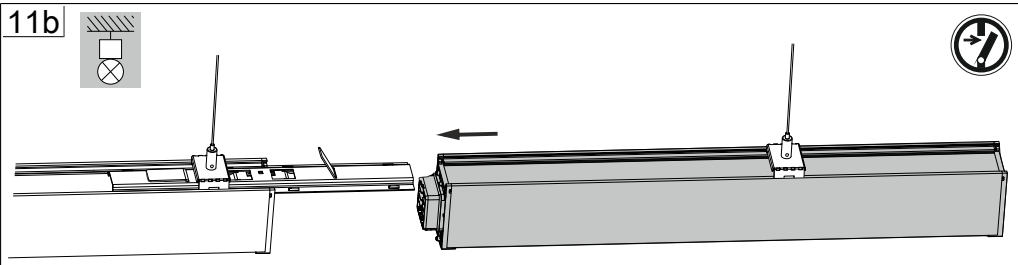
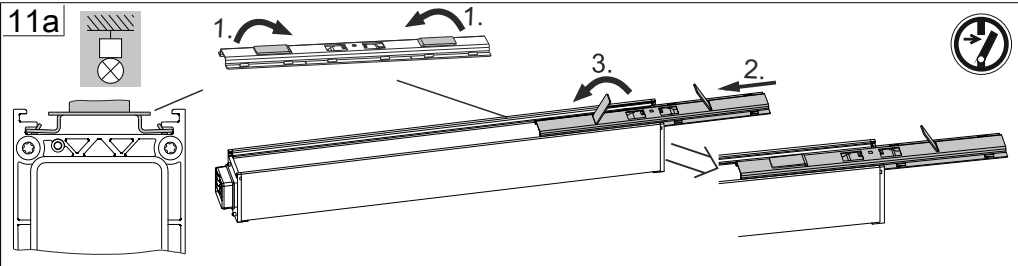



13b

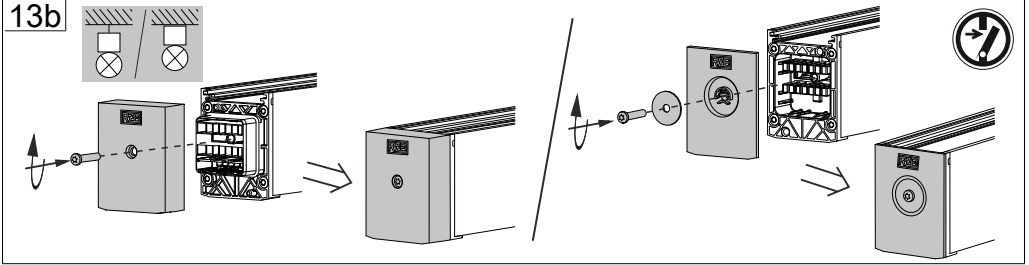

14

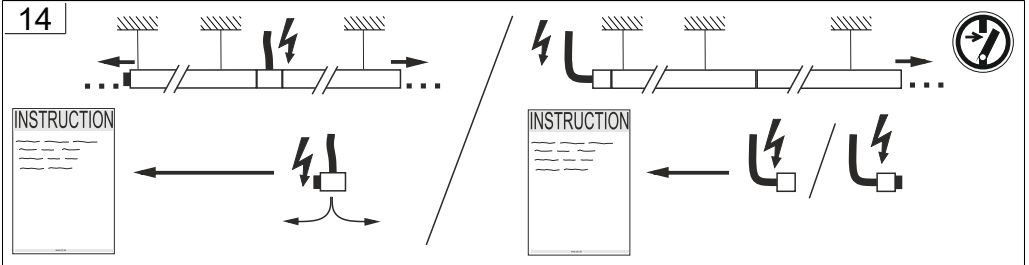



Bei Fragen zu unseren Symbolen,
besuchen Sie folgende Webseite:

If you have any questions about our
signs, visit the following website:



www.rzb.de/fileadmin/assets/downloads/PDF/RZB_Symbolklaerung.pdf

	Pendelmontage / Pendant mounting Einspeisung von der Seite / Feed from the side		Stecker / Plug
	Deckenmontage / Ceiling mounting Einspeisung von der Seite / Feed from the side		Buchse / Socket
	Pendelmontage / Pendant mounting Einspeisung von Oben / Feed from above		Pendelmontage / Pendant mounting
	Deckenmontage / Ceiling mounting Einspeisung von Oben / Feed from above		Deckenmontage / Ceiling mounting

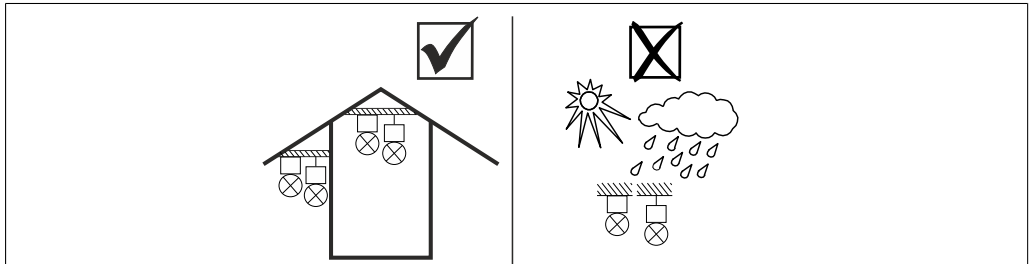
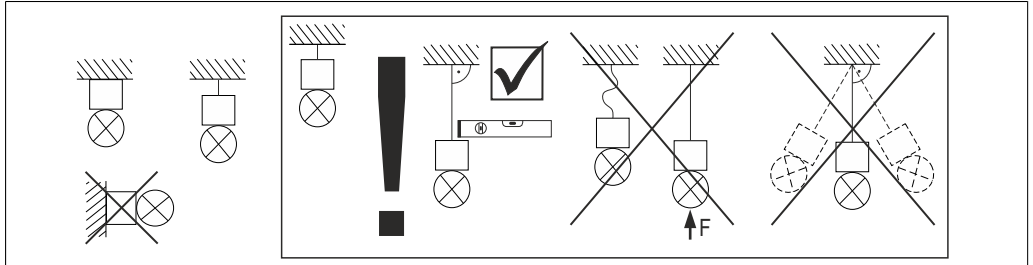







Hinweis zum Einsatz von Leuchten mit ∇ -Kennzeichnung nach EN 60598-2-24
Reference for application of lumiaires with ∇ - marking according to EN 60598-2-24

	Umgebung ohne Staubablagerung Environment without dust deposit
	Umgebung mit nicht elektrisch leitender Staubablagerung Environment with non-electrically conductive dust deposit
	Umgebung mit elektrisch leitender Staubablagerung Environment with electrically conductive dust deposit



	982678.003.2	Einspeisung Feed	L 312, B 58, H 76	673 g
	982678.003.3	Einspeisung Feed	L 330, B 58, H 76	673 g
	982698.003.3	Einspeisung Feed	L 330, B 58, H 76	751 g
	982698.003.4	Einspeisung Feed	L 312, B 58, H 76	751 g
	982698.003.5	Einspeisung Feed	L 349, B 58, H 76	751 g
	982661.000	Pendelset Pendant kit	, LP 1500	56 g
	982662.000	Pendelset Pendant kit	, LP 1500	240 g
	982663.000	Befestigungsset Fixture	L 33, B 54,	63 g
	982664.000	Befestigungsset Fixture	L 33, B 54,	39,1 g
	982665.000	Pendelset Pendant kit	, LP 1500	80 g
	982717.000	Pendelset Pendant kit	, LP 5000	190 g
	982718.000	Pendelset Pendant kit	L 54, B 30, H 14, LP 5000	240 g



	982719.000	Pendelset Pendant kit	L 54, B 30, H 42, LP 5000	270 g
	982580.010	Deckenmontageset Ceiling surface mounting kit	L 70, B 28, H 16	44 g
	982666.000	Befestigungsset Fixture	L 70, B 54, H 22	25 g
	982699.003	Endkappe End cap	L 16, B 58, H 76	21,5 g
	982700.003	Endkappe End cap	L 23, B 58, H 76	31 g
	982680.000	Verbinder Connector	L 300, B 48, H 9	181 g



RZB - Rudolf Zimmermann, Bamberg GmbH
Rheinstraße 16
96052 Bamberg

☎ 0951/7909-0
Fax: 0951/7909-198

E-mail: info@rzb-leuchten.de